

Data Sheet



Article number: 604133028085

Description: Taper bored timing belt pulley
HTD 28 14M 85 TL 2517

Measures

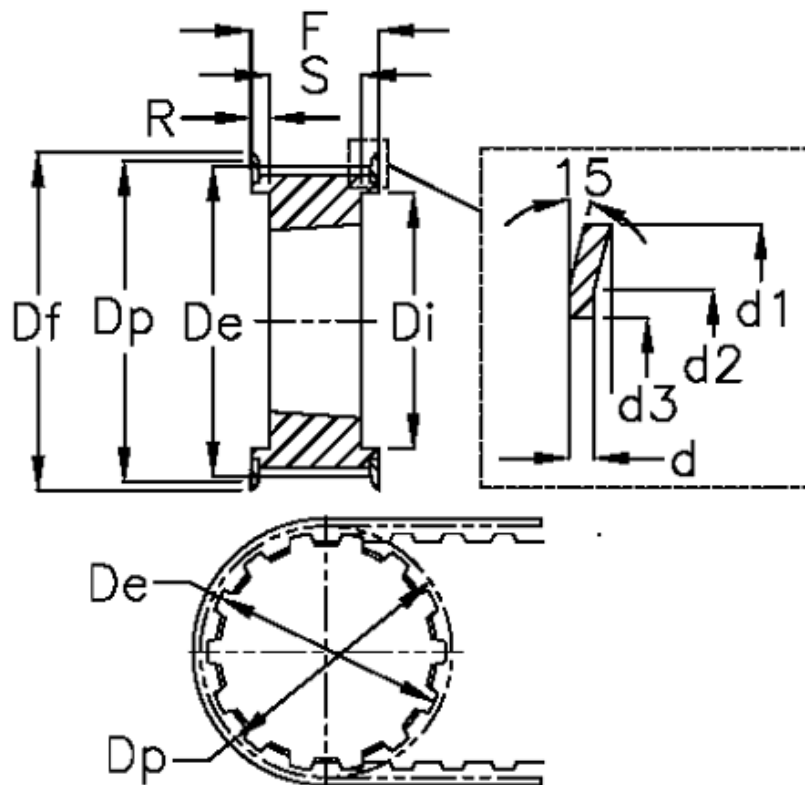

d = 2.5	F = 102	Weight = 2.7
d1 = 128	Flange type = F40	Width = 85
d2 = 124	For bushing = 2517	
d3 = 107	Max bore = 60	
De = 122.12	r = 28.5	
Df = 128	S = 45	
Di = 98	Tooth number = 28	
Dp = 124.78	Type = 14M	